

55.0000.06



55.0000.03



**MeccanotticaMazza**<sup>srl</sup>  
attrezzature oftalmiche



**MEC BOX 3C 55.000.03:**  
cassettiera 3 cassetti su ruote

**MEC BOX 3C 55.000.03:**  
chest of 3 drawers with castors



**MEC BOX C 55.015.02:**  
cassetto aggiuntivo  
porta vassoio lenti (optional)

**MEC BOX C 55.015.02:**  
auxiliary drawer  
with lens tray (optional)



**MEC BOX 6C 55.000.06:**  
cassettiera 6 cassetti su ruote

**MEC BOX 6C 55.000.06:**  
chest of 6 drawers with castors



MEC BOX 6S SS.010.06:  
cassettiera 6 cassetti con console comandi

MEC BOX 6S SS.010.06:  
chest of 6 drawers with control panel console



MEC BOX INS SS.015.01:  
modulo supplementare strumenti a mano

MEC BOX INS SS.015.01:  
auxiliary hand instruments support



MEC BOX 3S SS.010.03:  
cassettiera a 3 cassetti  
con console comandi  
supporto strumenti a mano [optional]

MEC BOX 3S SS.010.03:  
chest of 3 drawers  
with control panel console  
hand instruments support [optional]



55.030.00



55.020.00



**MeccanotticaMazza**<sub>sr</sub>  
attrezzature oftalmiche



**MEC BOX JOLLY SS.020.00:**  
 modulo con 2 cassetti e due piani

**MEC BOX JOLLY SS.020.00:**  
 module with 2 drawers and 2 planes

**MEC BOX AUX SS.015.04:**  
 pianetto aggiuntivo

**MEC BOX AUX SS.015.04:**  
 auxiliary plane



**MEC BOX T SS.015.03:**  
 pianetto aggiuntivo  
 porta tastiera - mouse

**MEC BOX T SS.015.03:**  
 auxiliary keyboard  
 and mouse plane



**MEC BOX PC SS.030.00:**  
 modulo porta PC con 1 cassetto e 3 piani

**MEC BOX PC SS.030.00:**  
 PC module with 1 drawer and 3 planes



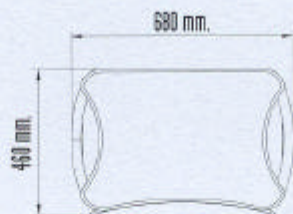
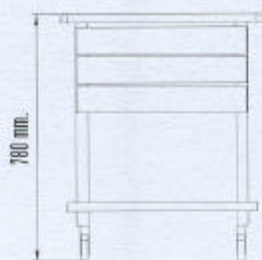

55.000.03

55.000.06

FR11 - Spicchi Frigorifero

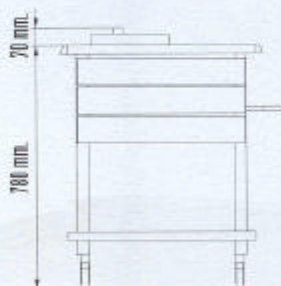

55.010.03

55.010.06

Stampato nel settembre 2002

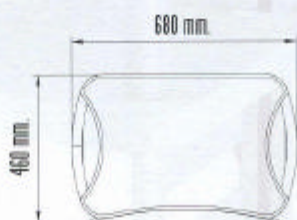
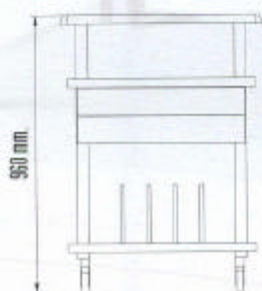

55.020.00

I diritti riprodotto nel presente opuscolo non sono vincolanti. Lo Meccanottica Mazza si riserva il diritto di apportare modifiche alle costruzioni ed al disegno.  
Meccanottica Mazza reserves the right to modify product features and product design without notice.

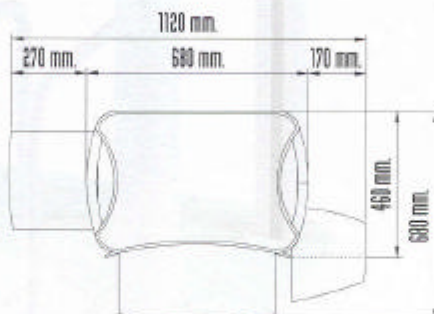
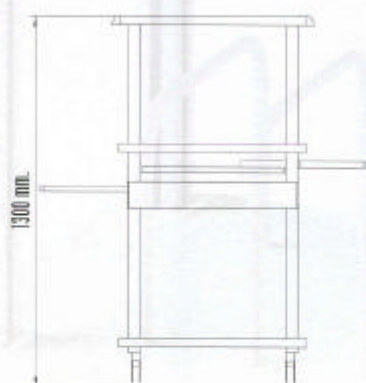

55.030.00



**MeccanotticaMazza** srl  
**attrezzature oftalmiche**

20048 CARATE BRIANZA (MI) - ITALIA - VIA TIZIANO, 9  
TEL. +39.0362.902185-900709-991966 FAX +39.0362.903306  
mecca@meccanotticamazza.it  
www.meccanotticamazza.it

CERTIFIED  
QUALITY SYSTEM  
UNI EN ISO 9001



**ANCCP**  
Notifica CE 0302

CONFORME ALLA MARCATURA